



forma-storTM

Operational and maintenance manual

Suitable for: FR200-TT, FR400-TT



1-877-794-2848 >> info@armorgardusa.com



Welcome

Welcome to your Armorgard Forma-Stor. This quick-assembly, modular solution for jobsite storage can be easily built in as little as 10 minutes. Please consult this manual for instructions on how to get the most from the unit.

Please read this operational and maintenance manual carefully prior to setting up the Forma-Stor. Always keep this manual with the product and read prior to use.

Contents

Safety information.....	4
Product specification.....	6
What's included.....	7
Tools you'll need.....	8
Getting to know your Forma-Stor.....	9
Padlock housing dimensions.....	11
How to assemble.....	12
Dismantling the Forma-Stor.....	15
How to install the locking rods.....	16
How to use the lock.....	18
Using the lifting eyes.....	20
Optional extras.....	21
Installing the shelves.....	22
Installing the ramp.....	23
Installing the BlokkaBar.....	24
Using the BlokkaBar.....	25
Storing the unit.....	26
Transporting the unit.....	27
Equipment care & ongoing maintenance.....	28
Warranty.....	29
Spare parts.....	31



Safety information

- » Before using the Forma-Stor, ensure any relevant risk assessments are carried out. Armorgard cannot be responsible for accidents that occur due to negligence.
- » At least two people are required to erect or dismantle the Forma-Stor and all relevant PPE must be worn while doing so. Never lift if not comfortable to do so.
- » The Forma-Stor must be positioned on a flat, solid surface, and should be level and stable before being used.
- » Ensure the Forma-Stor is fully assembled and that it is empty before lifting or moving it. Only qualified personnel should lift the Forma-Stor.
- » It is important to ensure that our guidelines are followed when assembling the Forma-Stor, and extra care is needed when lifting panels.
- » Ensure that all parts are in good working condition prior to using the Forma-Stor.
- » Always lock the Forma-Stor when it's not in use or out of sight. Do NOT leave keys inside the unit while locking.
- » The unit is compatible with most padlocks (which are not included). We recommend using the MasterLock #5 or the American Lock A50. Please contact a member of the team if uncertain.
- » Only use UL or CSA listed electrical devices that meet the requirements of the local jurisdiction.
- » Any modification to or unintended use of this product could create a danger of an explosion or other hazardous condition that can result in death, serious personal injury or property damage.
- » Keep hands clear when closing door. Failure to do so could result in severe injury.
- » This product is not designed for storing or transporting flammables, explosives, hazardous wastes or hazardous materials such as containers of solvents, gun powder, dynamite, gasoline, propane, or acetylene tanks, etc.



- » Lifting hazard. Single person lift could cause injury. Use assistance when lifting.
- » Always follow safe lifting practices. You should stand as close to the load as possible so you don't exert more force onto your back by extending the distance. Then bend your knees and keep your upper body upright so your legs do the lifting rather than your back. Look straight ahead and keep your back straight and shoulders back so you have a slight arch in your lower back. Seek assistance from another person or a lifting device if the weight exceeds what you are comfortable lifting alone.

While every effort has been made to ensure this operational and maintenance manual covers every aspect needed to operate your product safely, please take care while using the product and always operate with caution. Always liaise with management personnel on site for any additional operational restrictions that you need to be aware of.

Do

✓ Secure all locks when not in use

✓ Ensure parts are fully slotted together

✓ Ensure it's safe when opening/closing door

✓ Ensure all correct fixings are used

Don't

✗ Leave unlocked when unattended

✗ Leave keys or living things inside unit

✗ Forget to do integrity checks before lifting

✗ Position on an uneven surface



Product specification

Product Code	Description	Weight (lbs)	External Dimensions W x D x H (inches)	Internal Dimensions W x D x H (inches)
FR200-TT	Flat pack store	845	81.7 x 79.1 x 81.3	75.4 x 72.4 x 73.4
FR400-TT	Flat pack store	1313	81.7 x 155.9 x 81.3	75.4 x 149.2 x 73.4

Individual panel weight (lbs)	Back panel	Door panel	Side panel	Roof panel	Base
FR200-TT	123	168	117	117	249
FR400-TT	123	168	251	212	410

What's included...

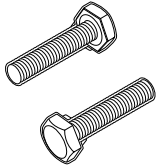

8x M12x45mm bolts
(FR200-TT)
12x M12x45mm bolts
(FR400-TT)



8x M12x20mm bolts



8x pipe lynch pins

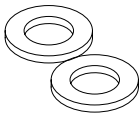

16x M12 washers
(FR200-TT)
20x M12 washers
(FR400-TT)



4x lifting eyes with rubber
washer



1x door panel
79x79"



2x side panels
79x79" (FR200-TT)
158x79" (FR400-TT)



1x roof panel
79x79" (FR200-TT)
79x158" (FR400-TT)



1x base panel
79x79" (FR200-TT)
79x158" (FR400-TT)



1x rear panel
79x79"

Tools you'll need...

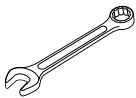

3/4" or adjustable
wrench



Screwdriver



An impact driver
with 3/4" socket



Multiple
people
needed

Getting to know your forma-stor™

This quick-assembly, modular solution for jobsite storage can be easily built in as little as 10 minutes.

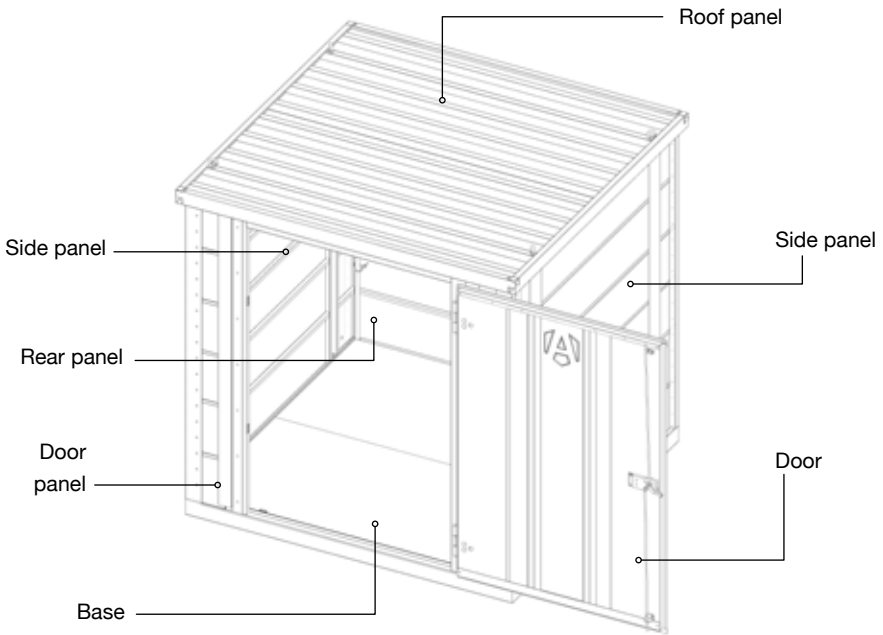

T-Latch Lock



Crane lifting eyes



Forklift pockets



Collapsible



Stackable

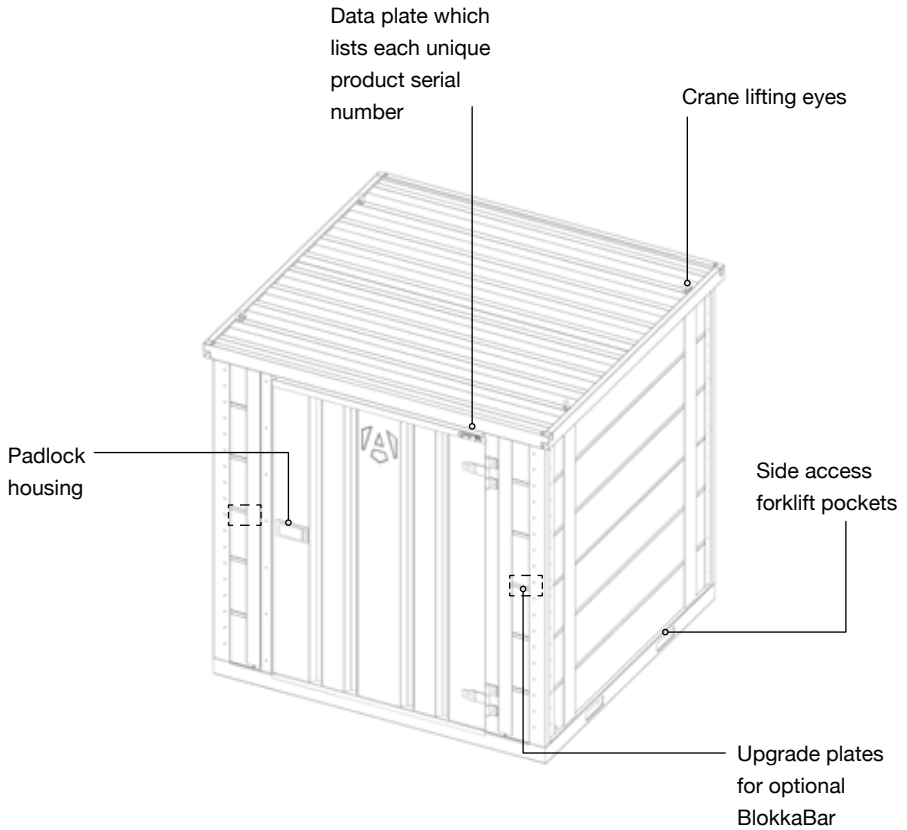

14 gauge and 19 gauge steel



Suitable for use on-site



Add up to 5 shelves

Padlock housing dimensions

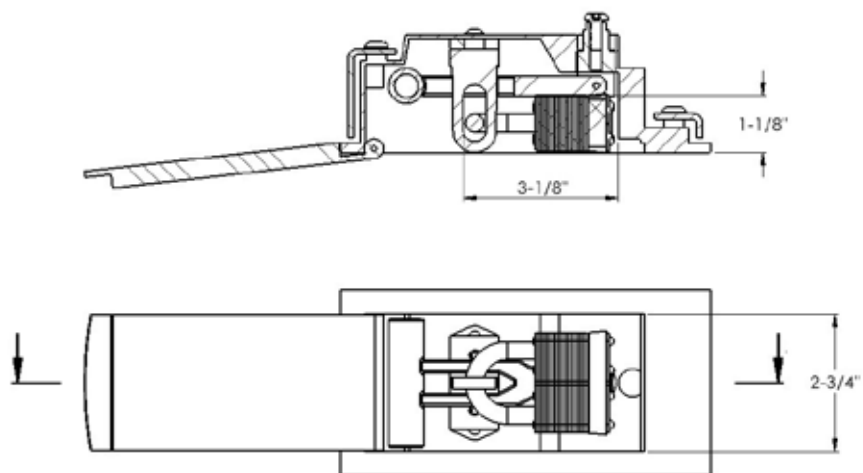



How to assemble

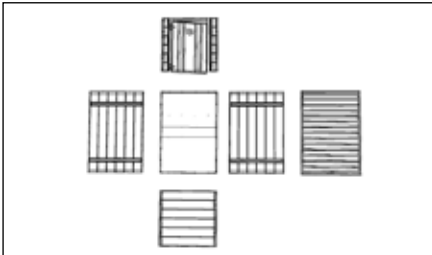

- 1.** Familiarise yourself with all panels' positions and orientation, i.e. the top of each panel. Attach the crane lifting eyes onto the roof.



- 2.** With the base on a level, stable surface, place one of the side panels on the base, and support it in an upright position.

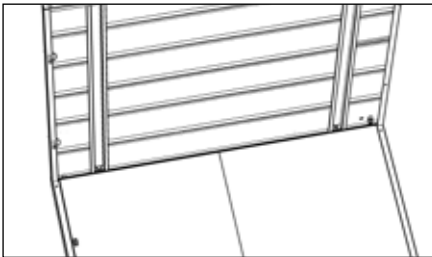

- 3.** Secure the side panel to the base using two M12x20 bolts in each hole along the side panel.

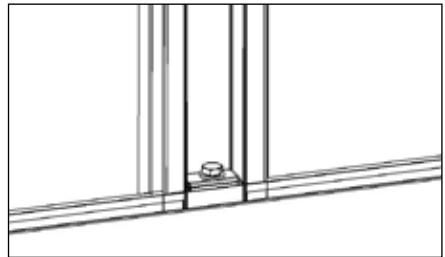

- 4.** Ensure it is supported safely while you use the M12x45mm bolts and washers to secure the side to the base in two positions. Do not fully tighten until all panels are fitted.

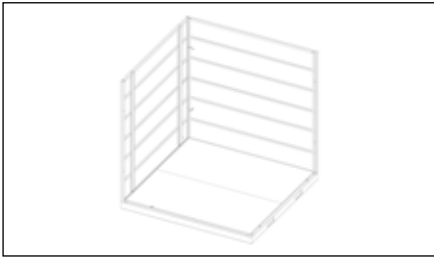

- 5.** Next, position the rear panel to form a corner.

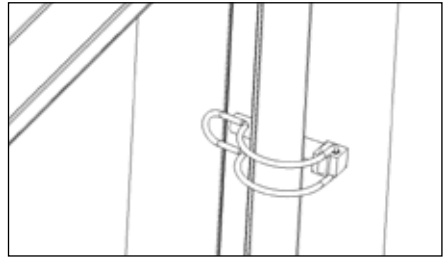

- 6.** Attach pipe lynch pins in each corner. This will enable the rear panel to support the side panel. Then, secure the bolts through the base as per step 4.

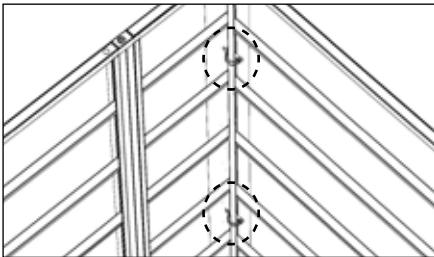

- 7.** There are two lynch pins for each corner. Secure the rear panel to the base as described in step 3.



- 8.** Place the other side panel on the base, and secure it to the base panel with bolts as described in steps 3-4. Fit two lynch pins in the corner.



- 9.** Slot the door panel into place and secure to the side panels with linch pins as described in step 6, and bolts as described in step 3 and 4. Ensure the door is fully supported before opening for the next step.

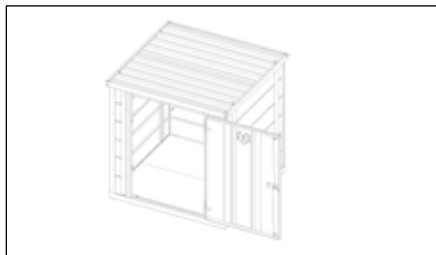

- 10.** Now place the roof on top. The roof is heavy and care should be taken when lifting into position. Please take all safety precautions necessary when moving this part. Extra people or equipment may be required to lift safely.

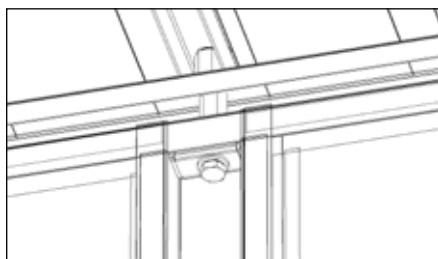

- 11.** Secure the roof panel to both side panels using M12x45mm bolts and washers in four positions on the inside of the Forma-Stor.



- 12.** Finally, fully tighten all fixings and lifting eyes, ensuring that none are missed.

Dismantling the Forma-Stor

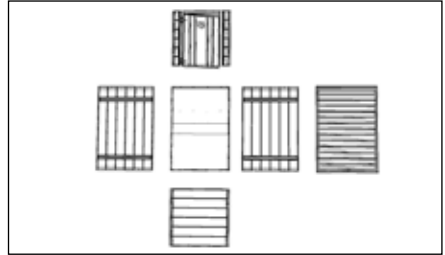
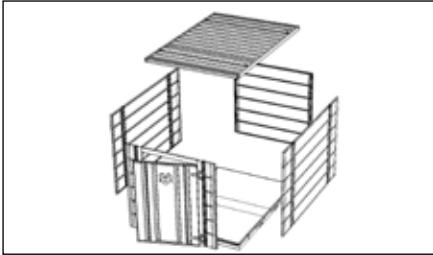

1. To dismantle the Forma-Stor, remove the parts in reverse order to which they were assembled.

2. Remove the roof first, followed by the door panel, a side panel, the rear panel, and then the remaining side panel. Bolts can be threaded back into the panels for safekeeping.



3. The Forma-Stor can then be stacked in its flat-packed form. Please note that you **MUST** remove the locking rods before dismantling.



How to install the locking rods

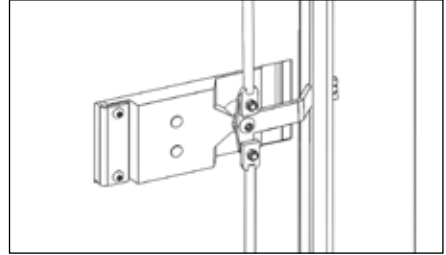
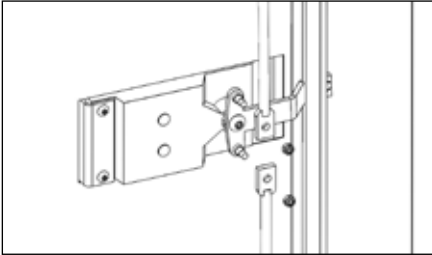

- 1.** Installations will take place inside of the Forma-Stor. Locate yourself inside the unit. Once inside, locate the back side of the door latch.
- 2.** Fit the rod onto the bolt of the latch as shown, then secure with nuts. Repeat for the opposite rod.

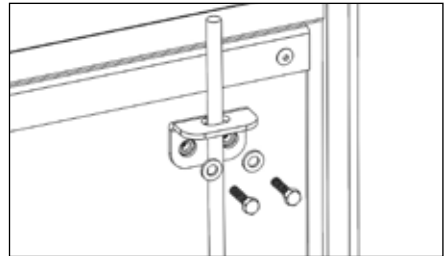

- 3.** Take the upper support angle and slide its slot through the edge of the top rod.
- 4.** Align the perforations of the angle with the rivet nuts already located on the door and use a washer and bolt to secure the angle bracket in place.

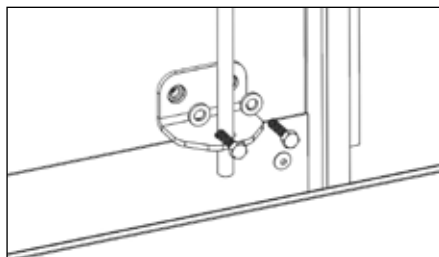

- 5.** Repeat the previous step for the bottom rod using the lower support angle.

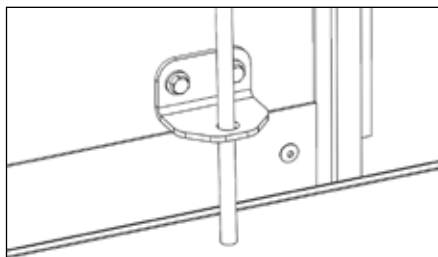

- 6.** After both angles are placed, pull down the bottom rod until it touches the floor and mark the position of it.

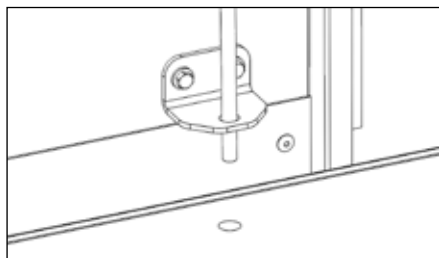

- 7.** Use the previous mark as a reference to drill a 1/2" hole on the floor panel.

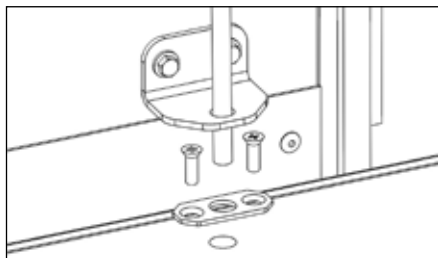

- 8.** Finally, take the lock plate and align its middle perforation to the one on the floor. Use wood screws to secure the plate in its final position.



How to use the lock

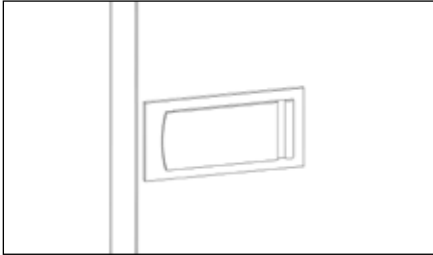

- 1.** To open the unit, locate the lock housing at the center of the door. Open the cover plate to expose the locking mechanism.

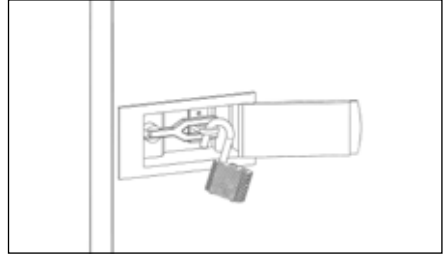

- 2.** Unlock the padlock and remove it.

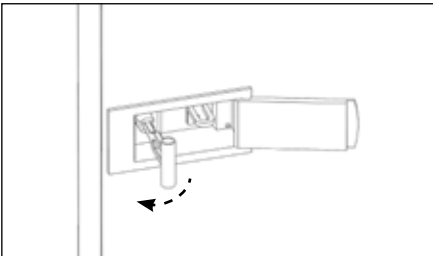

- 3.** Grab the T Handle and swing it to the left until it's perpendicular to the front face of the door.

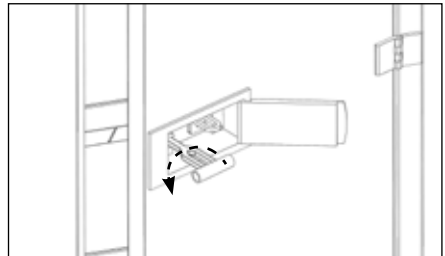

- 4.** Twist the handle 90° to release the door and pull to open it.

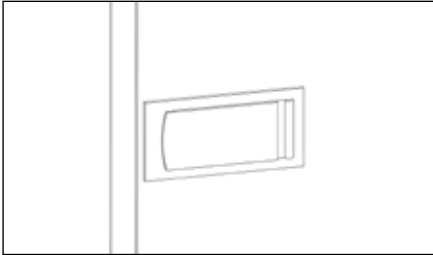

- 5.** To lock the unit, shut the door, then open the cover plate to expose the locking mechanism.

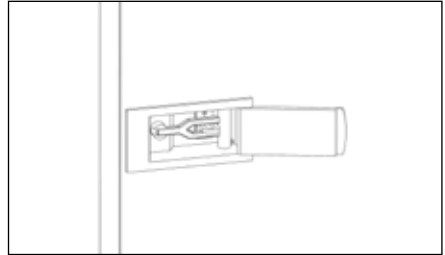

- 6.** Ensure the T Handle is parallel to the front face of the door.

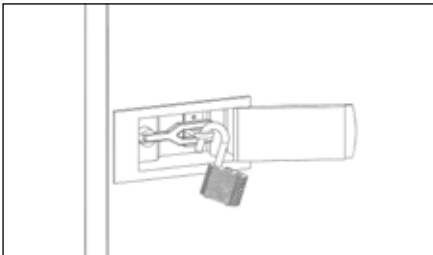

- 7.** Slide an unlocked padlock into the inner shackle of the pocket to prevent the movement of the T Handle.

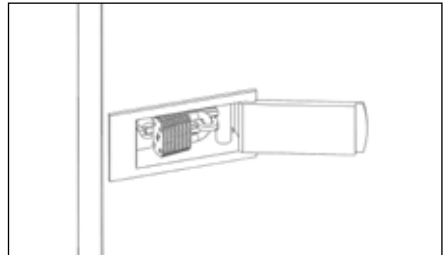

- 8.** Lock the padlock, and fit it into the lock housing. After removing the key, the cover plate should be able to close easily.



Using the lifting eyes

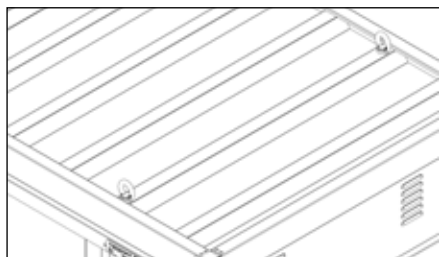

- 1.** Before lifting, ensure that the internal bolts holding the lifting eyes are securely in place.

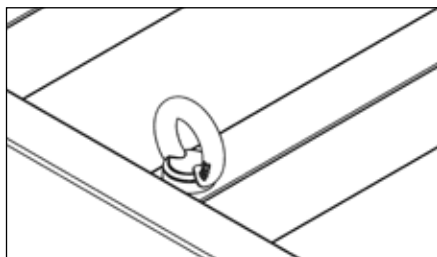

- 2.** Attach the lifting equipment to all four lifting eyes and ensure that the load is lifted evenly across all four eyes.

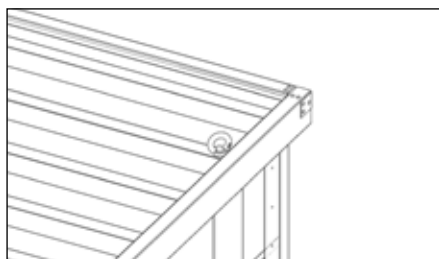

- 3.** Lifting eyes should only be used once confirmed by a qualified person on site.

Warning! The lifting eyes are only provided for positioning of the Forma-Stor, and the unit must be empty while lifting. Before lifting, each lifting eye must be checked that it is undamaged and installed correctly, and should be inspected by a lifting operator before use.

Take your forma-stor™ to the next level with these optional extras

Contact the Armorgard team to find out more about the optional extras for your product.

Shelves

To organize and store equipment.



Ramp

To improve accessibility when moving heavy equipment.



BlokkaBar

To enhance your Forma-Stor's security



Please note that each size Forma-Stor unit can fit up to five shelves.



Installing the shelves (optional extra)

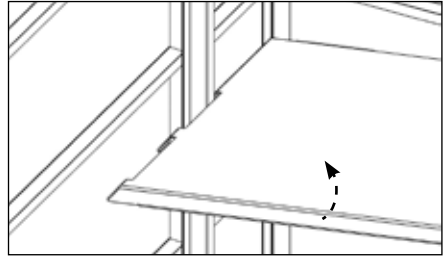
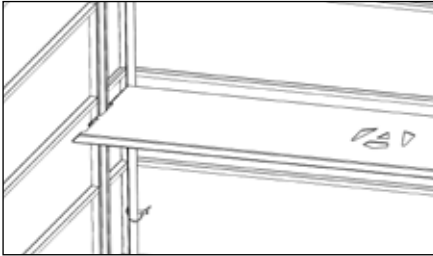

1. Each size Forma-Stor unit can fit up to five shelves. Do not exceed the 440lbs UDL the shelf was designed for. No fixings are required for shelves.

2. Locate the relevant inner slots on the back panel, and position the shelf by tilting and inserting the pocket on its edge into the back vertical support of the side panel.

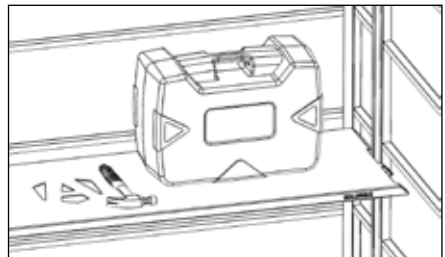
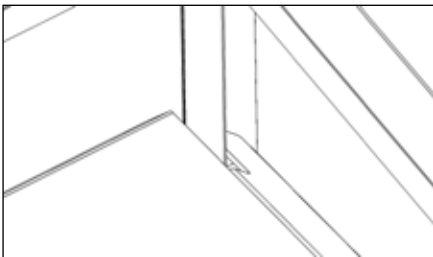

3. Rest the shelf into position. It will need to align with the corner of the unit with one of its cut-outs. Repeat the steps to install the other shelves.

4. Test the shelves by pushing down with force and ensuring it doesn't slip before loading with any contents.

Installing the ramp (optional extra)

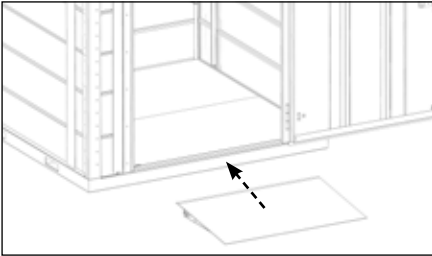

- 1.** Position the ramp along the opening of the Forma-Stor, with the doors of the unit open to improve accessibility when moving equipment.
- 2.** When using the ramp, do not exceed the 2200lbs UDL that it was designed for. Do not close the door whilst the ramp is in position.



Installing the BlokkaBar (optional extra)

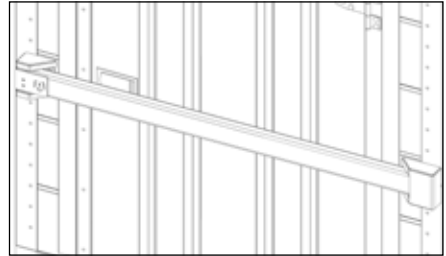
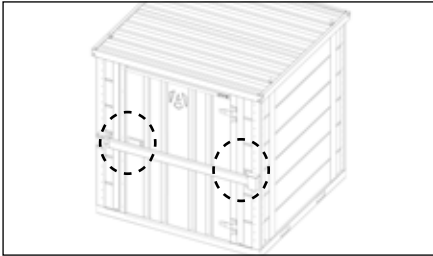

- 1.** To install the BlokkaBar, locate the pre-drilled holes on either side of the door. Then, remove the coach bolts and blanking plate.
- 2.** Place the lock housing of the BlokkaBar on the left side of the door. The other housing should be placed on the right side of the door.

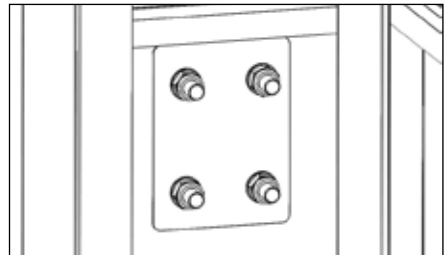
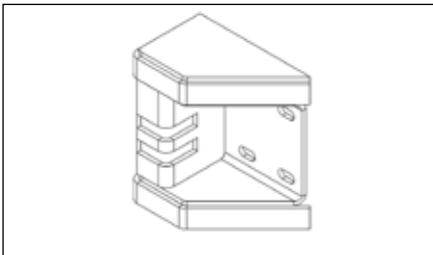

- 3.** Ensure the padlock is located in the locking housing with the lock facing down. Push the coach bolts through the holes in each housing and place into the pre-drilled holes in the Forma-Stor.
- 4.** Inside the Forma-Stor, replace with the blanking plate and then place a washer and nylock nut on each bolt. Repeat for both housings.

Using the BlokkaBar

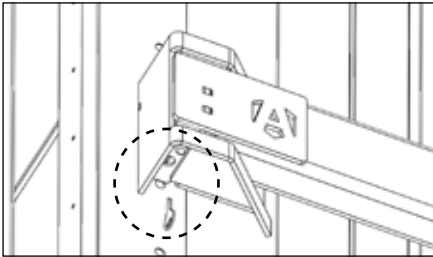

- 1.** To unlock the BlokkaBar, place the key in the keyhole of the lock on the bottom, and turn. This will unlock, releasing the pin.

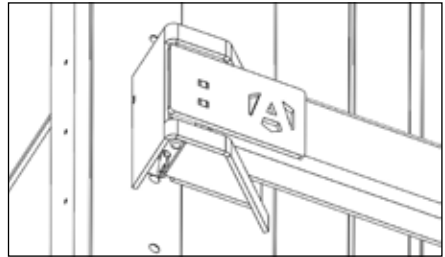

- 2.** Remove the bar by pulling it and sliding it to the left. This will allow the access to the door's locking system.

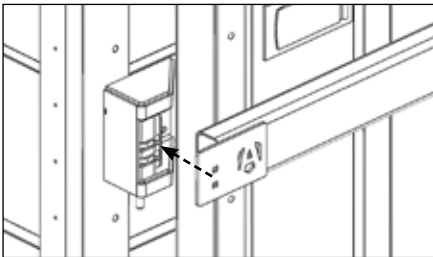

- 3.** To lock for maximum security, ensure that the Forma-Stor door is locked before placing the BlokkaBar. Slide the bar in place.



- 4.** Then, push in the pin of the lock that is located at the bottom of the left lock housing of the BlokkaBar, this will ensure everything is secure in place.

Important! Please note that spare keys are not available for the BlokkaBar.



Storing the unit

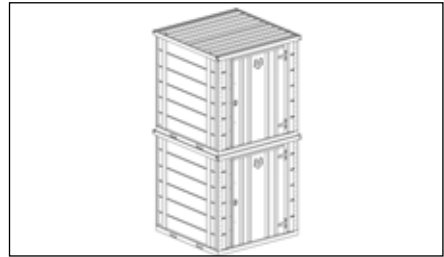

- 1.** The Forma-Stor can be stacked in its flat-packed form to save space when storing. Please note that you **MUST** remove the locking rods before dismantling.

- 2.** To save space, Forma-Stor that are assembled can be safely stacked up to two stories high when empty.



- 3.** Ensure that all locks are secured when leaving the Forma-Stor unattended. Use the BlokkaBar to enhance security if needed.

Transporting the unit

The design of the Forma-Stor makes transporting the product easy.

The four crane lifting eyes come with the Forma-Stor and are attached to the roof. These are for ease of transporting the unit only. The unit should never be lifted when loaded.

Always use the forklift pockets when transporting by forklift.

When lifting the panels, use a dolly to ease manual handling if the panels are too heavy.

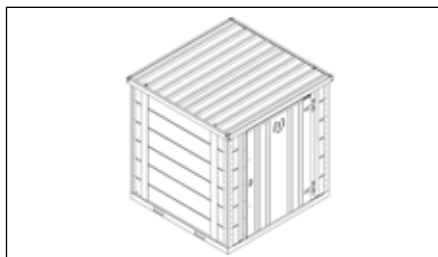
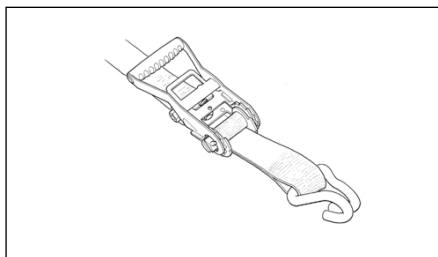

1. During transport, ensure that the Forma-Stor is secured by strapping down the unit fully.

2. If transporting erected, ensure the door is secured and locked.



Equipment care

The Forma-Stor is weather resistant, galvanised and finished with a durable powder coating, so it is suitable for outdoor use, however it does not mean it is waterproof. It is always important to note that any electrical components or equipment susceptible to water damage should be sealed and placed higher up the Forma-Stor, using the optional shelves if necessary.

It is important to ensure that all Forma-Stor bolts remain in good condition and that they are always bolted on tightly.

Always ensure that the product data plate remains visible and in good condition, especially the unique serial number.

Ongoing maintenance

It is important to check that the Forma-Stor is not damaged before every use.

We recommend for you to check the bolts, locks, forklift pockets, crane lifting eyes and any optional extras every three months, to ensure that the Forma-Stor can operate fully. If the Forma-Stor will be under rigorous use, we recommend integrity checking regularly.

Always carry out integrity checks before lifting the Forma-Stor.

Apply light oil to hinges for smoother operation.

Warranty

Armorgard products are built to last, and all have a manufacturer's warranty of seven years - please refer to the terms and conditions for what this covers.

Do not force entry into the product, as this could affect the warranty. Contact your padlock distributor if you require a replacement lock or key.

1 Limited Warranty

1.1 The Seller Warrants to Buyer That for a Period of Seven (7) Years From the Delivery of the Goods ("warranty Period"), Such Goods Will Materially Conform to the Seller's Published Specifications at the Time of Delivery and Will Be Free From Material Defects in Workmanship.

1.2 Except for the Limited Warranty Set Forth in Section 10.1, the Seller Makes No Warranty Whatsoever With Respect to the Goods, Including Any (a) Warranty of Merchantability; (B) Warranty of Fitness for a Particular Purpose; (C) Warranty of Title; or (D) Warranty Against Infringement of Intellectual Property Rights of a Third Party; Whether Express or Implied by Law, Course of Dealing, Course of Performance, Usage of Trade or Otherwise.

1.3 Products Manufactured by a Third Party ("third Party Product") May Constitute, Contain, Be Contained in, Incorporated Into, Attached to or Packaged Together With, the Goods. Third Party Products Are Not Covered by the Limited Warranty in Section 1.1. for the Avoidance of Doubt, the Seller Makes No Representations or Warranties With Respect to Any Third Party Product, Including Any (a) Warranty of Merchantability; (B) Warranty of Fitness for a Particular Purpose; (C) Warranty of Title; or (D) Warranty Against Infringement of Intellectual Property Rights of a Third Party; Whether Express or Implied by Law, Course of Dealing, Course of Performance, Usage of Trade or Otherwise.

1.4 The Seller Shall Not Be Liable for a Breach of the Limited Warranty in Section 10.1 if the:



1.4.1 Defect Arises Because the Buyer Failed to Follow the Seller's Oral or Written Instructions as to the Storage, Installation, Commissioning, Use or Maintenance of the Goods or (if There Are None) Good Trade Practice;

1.4.2 The Buyer Alters or Repairs the Goods Without the Written Consent of the Seller;

1.4.3 Defect Arises From Fair Wear and Tear (as Determined by the Seller in Its Sole and Absolute Discretion), Cosmetic Rust, Scratches, Dents, or Willful Damage, Negligence, Abnormal Working Conditions or Misuse, Environmental or Other External Factors;

1.4.4 The Buyer Makes Any Further Use of the Goods After Giving Notice of a Defect in Writing to the Buyer;

1.4.5 Defect Arises as a Result of the Seller Following Any Drawing, Design or Specification Supplied by the Buyer;

1.4.6 The Defect or Imperfection is of a Minor or Insignificant Nature in Respect of the Goods; or

1.4.7 The Goods Differ From Their Description or Specification as a Result of Changes Made to Ensure They Comply With Applicable Statutory or Regulatory Requirements.

1.5 Subject to Section 1.3 and 1.4 and the Seller's Right to Examine Such Goods, if Any of the Goods Do Not Comply With the Warranty in Section 1.1, the Seller's Liability Shall Be Limited (at the Seller's Option) to the Repair or Replacement of Such Goods (or the Defective Part(S) in Question) or the Refund of the Price (or a Proportionate Part of the Price), and the Seller Shall Have No Further Liability to the Buyer.

1.6 If the Seller So Requests, the Buyer Shall, at the Seller's Expense, Return the Goods or the Defective Part(S) in Question to the Seller. Any Goods Replaced Will Belong to the Seller and Any Repaired or Replacement Goods Will Be Guaranteed on These Terms.

1.7 The Remedies Set Forth in This Section 1 Shall Be the Buyer's Sole and Exclusive Remedy and the Seller's Entire Liability for Any Breach of the Limited Warranty Set Forth in Section 1.1.

Spare parts



Other spare parts available. Please get in touch for more information.



Find us on social media:



UK Head Office

Unit 14-16, Standard Way, Fareham Industrial Park, Fareham, Hampshire, PO16 8XB
+44 (0) 23 9238 0280 | sales@armorgard.co.uk | www.armorgard.co.uk

France Office

+ 33 (0) 4 81 16 06 69
commercial@armorgard.fr
www.armorgard.fr

Australia Office

+61 (0) 1300 131 751
sales@armorgard.com.au
www.armorgard.com.au

New Zealand Office

0800 826 828
sales@armorgard.co.nz
www.armorgard.co.nz

North America Office

1-877-794-2848
info@armorgardusa.com
www.armorgardusa.com