

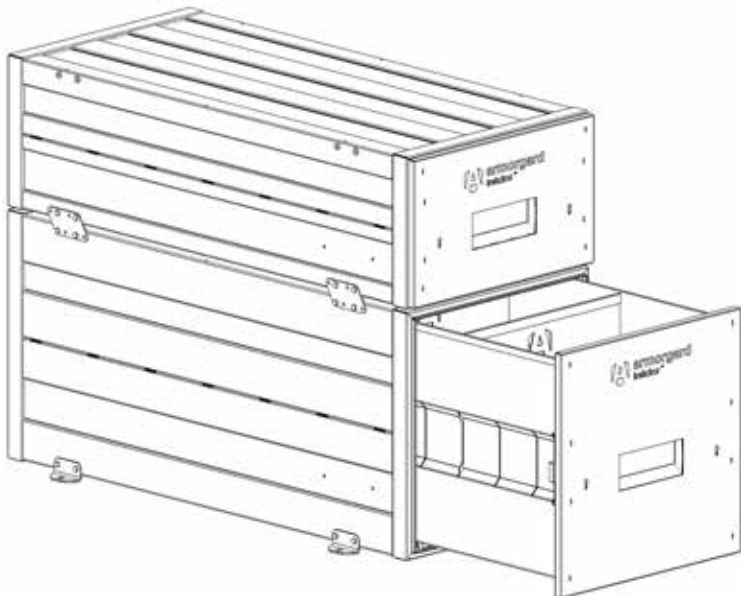

# trekdror<sup>TM</sup>

Operational and maintenance manual

Suitable for: TKD1, TKD2, TKD3





# Welcome

Welcome to your Armorgard TrekDror. Our range of robust steel tool drawers for vehicles and small spaces. Please consult this manual for instructions on how to adapt it to your needs.

**Please read this operational and maintenance manual carefully prior to setting up the TrekDror.**

---

# Contents

Safety information.....	4
Product specification.....	5
What's included.....	6
Tools you'll need.....	7
Getting to know your TrekDror.....	8
How to assemble.....	10
Optional extras.....	11
Mounting to a vehicle.....	12
Using the mounting kit (optional extra).....	13
Using the stacking kit (optional extra).....	15
Storing the unit.....	16
Transporting the unit.....	17
Equipment care.....	18
Ongoing maintenance.....	18
Warranty.....	19
Locks, keys and spare parts.....	19



# Safety information

- » At least two people are required to safely lift any TrekDror due to the weight.
- » Before using a TrekDror, ensure any relevant risk assessments are carried out. Armorgard cannot be responsible for accidents that occur due to negligence.
- » Ensure the TrekDror is empty before removing or fitting the drawer.
- » If you decide to fit the TrekDror to a vehicle, consult the vehicle manufacturer before carrying out any work to the vehicle itself.
- » When stacking TrekDrors, four brackets must be used to fully support the units. The base unit should always be secured to a solid floor or solid base.
- » Use caution when removing or replacing the drawer.
- » Ensure that all TrekDror parts are in good working condition prior to using unit.
- » When used in a vehicle or trailer, the TrekDror MUST be securely fastened down to prevent it moving in transit. We recommend using our mounting kits to do this.
- » If encasing the TrekDror, mounting up against the side of the serial plate, or building around the unit, please make a note of the serial number - should you need to request a replacement lock or key.

**Whilst every effort has been made to ensure this operational and maintenance manual covers every aspect needed to operate your product safely, please take care whilst using the product and always operate with caution. Always liaise with management personnel on site for any additional operational restrictions that you need to be aware of.**

<b>Do</b>	<b>Don't</b>
✓ Secure both locks when not in use	✗ Leave unlocked when lifting
✓ Ensure runners are kept clear of debris	✗ Force the drawer shut
✓ Ensure opening is clear when closing	✗ Stack incorrectly
✓ Fully support base when loaded	✗ Mount incorrectly

---

# Product specification

Product Code	Description	Weight (kg)	External Dimensions W x D x H (mm)	Internal Dimensions W x D x H (mm)
TKD1	TrekDror sliding van drawer	44	Drawer in: 490x1105x300 Drawer out: 490x1900x300	405x1040x245
TKD2	TrekDror sliding van drawer	63	Drawer in: 980x1105x200 Drawer out: 980x1905x200	900x1040x145
TKD3	TrekDror sliding van drawer	58	Drawer in: 490x1105x490mm Drawer out: 490x1905x490mm	405x1040x435

TrekDror UDL weight capacity on top	On top (kg)	Inside (kg)
TKD1	1,000	120
TKD2	160	120
TKD3	1,000	120

---



## What's included...



1x TrekDror



3x keys

---

## Tools you'll need...

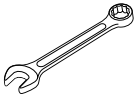

17mm spanner  
or socket (for  
mounting and  
stacking)

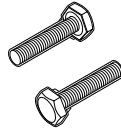

M10 bolts or oth-  
er suitable fixings  
(for mounting)



# Getting to know your TrekDror™

Robust steel tool drawers for vehicles  
and small spaces

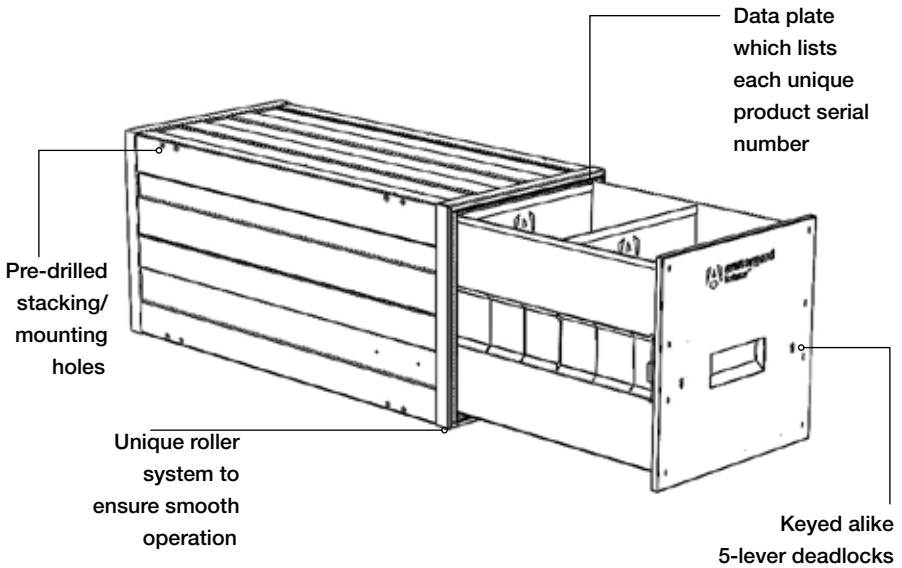

5-lever deadlocks



Stackable



Suitable for use  
in vehicle/van



1.5mm material  
thickness



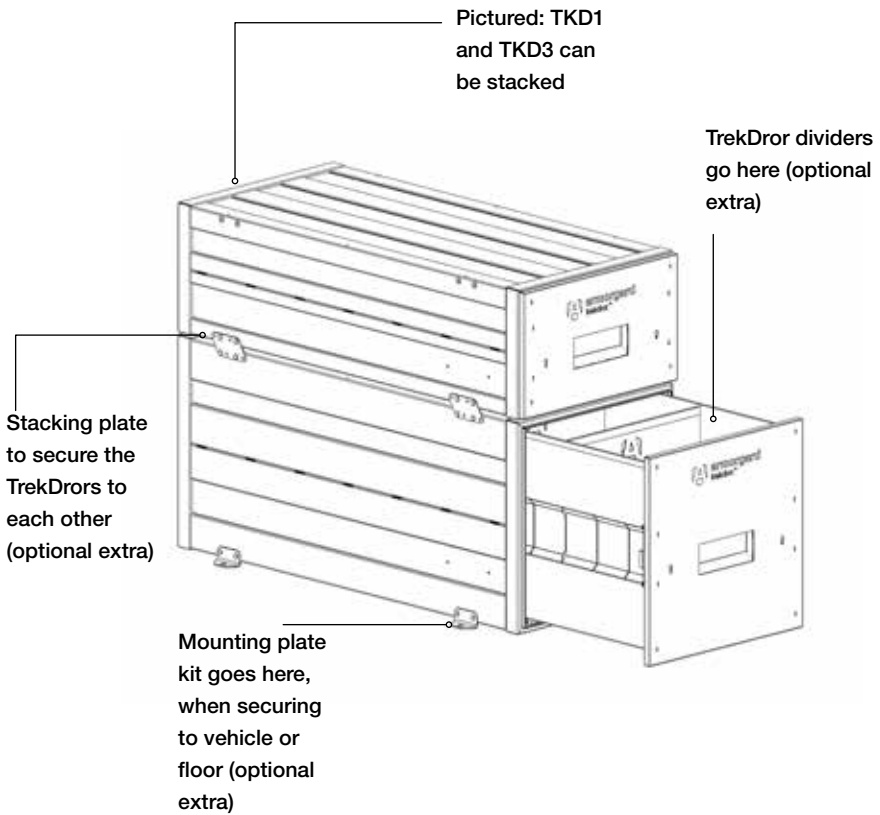



## How to assemble

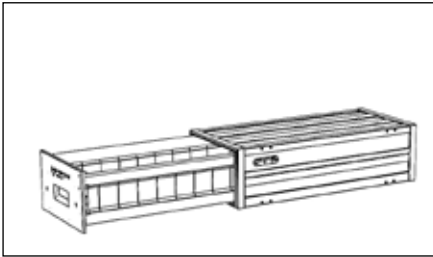

- 1.** The TrekDror arrives ready to use. To remove the drawer, pull it right out until it stops.

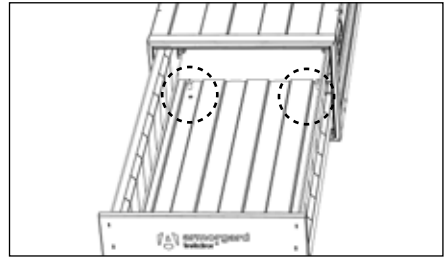

- 2.** Locate the two bolts inside the drawer at the rear.

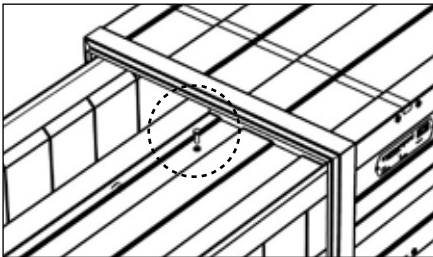

- 3.** Loosen these bolts until the drawer can slide out freely.

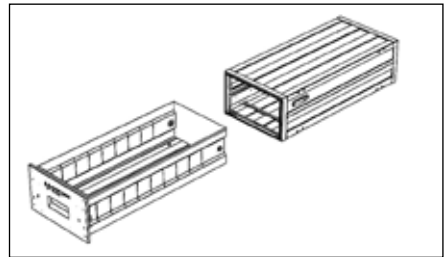

- 4.** The drawer can now be removed. When it is replaced, ensure that the bolts are tightened up again and test to ensure the drawer can't slide out completely.

---

# Take your trekdiror™ to the next level with these optional extras

Contact the Armorgard team to find out more about the optional extras for your product.



## Dividers

To organise equipment



## Stacking plate kit

Secures TrekDrors on top of each other



## Rubber mats

To avoid damage to both drawer and tools.



## Mounting plate kit

To fix the TrekDrors securely to the floor or a vehicle



## Mounting to a vehicle

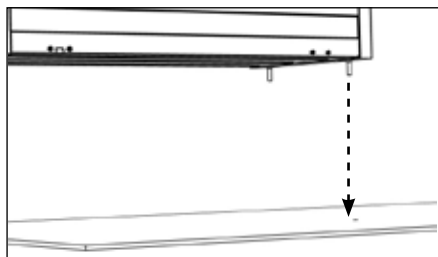

1. Remove the drawer and slot two M10 coach bolts into the fixing points at the rear of the casing. They should be fixed in place with shear nuts and spring washers. Drop the rear down through the prepared 11mm holes in the floor, and screw nuts onto the coach bolt from the other side of the surface.

If encasing the TrekDror, mounting up against the side of the serial plate, or building around the unit, please make a note of the serial number - should you need to request a replacement lock or key.

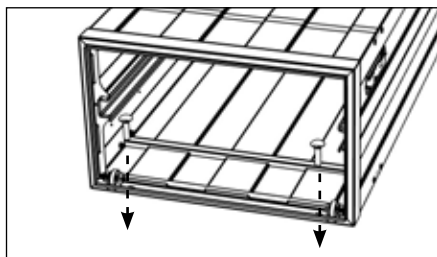

2. At the front, push the M10 bolts through from inside the casing. Ensure the casing is rigid and firm before fitting the drawer back in place.

When fitting a TrekDror to a vehicle, it is important that our guidelines **MUST** be followed. The vehicle manufacturer should always be consulted to ensure any proposed works will not damage the vehicle. Armorgard can not be held liable for any damage to the vehicle.

---

## Using the mounting kit (optional extra)

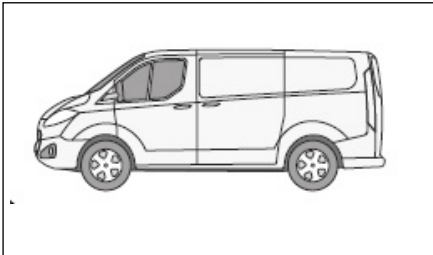

- 1.** Alternatively, use the optional mounting plate kit to fix your TrekDror to a vehicle. Begin by fitting the brackets from the mounting kit to the TrekDror.

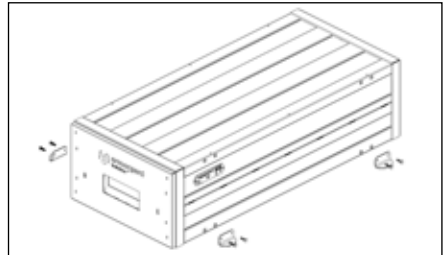

- 2.** Four brackets are included in the kit. Two should be fitted either side of the TrekDror using M6 bolts that can be tightened using a 10mm spanner or socket.

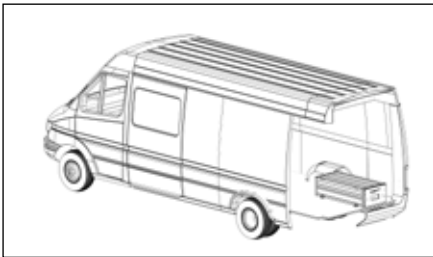

- 3.** Once the four brackets are fitted to the TrekDror, position this inside the vehicle to locate where to drill the 11mm fixing holes to anchor the unit.

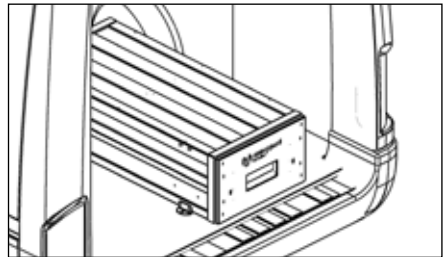

- 4.** Using the four supplied M10 coach bolts and a 17mm spanner or socket, secure the TrekDror via the mounting brackets with M10 spring washers and M10 shear nuts.

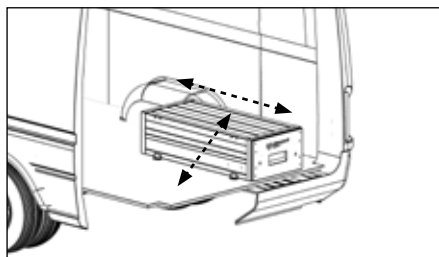

- 5.** Once installed, test by pushing and pulling the TrekDror vigorously in various directions. It is imperative that the unit is firmly fixed down.

When fitting a TrekDror to a vehicle, it is important that our guidelines **MUST** be followed. The vehicle manufacturer should always be consulted to ensure any proposed works will not damage the vehicle. Armorgard can not be held liable for any damage to the vehicle.

---

## Using the stacking kit (optional extra)

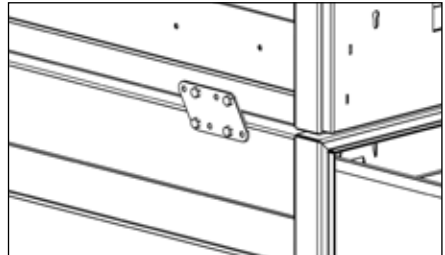
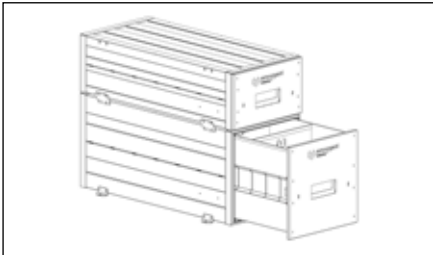

- 1.** If you have more than one TrekDror, they can be stacked in different layouts using the optional stacking plates. These create a small gap between the units.
- 2.** Bolt the stacking plates to the fixing points on the side of the TrekDrors. All four plates and 16 bolts are required to keep it rigid and secure.

When stacking the TrekDror, it is important that our guidelines **MUST** be followed.



## Storing the unit

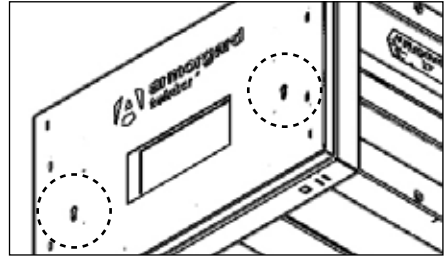
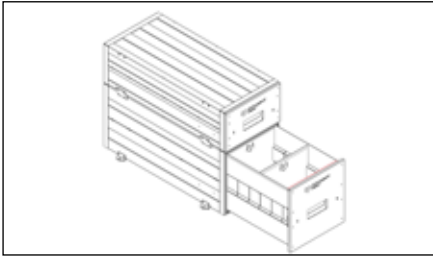

- 1.** The TrekDror is designed to save space with a pull-out drawer, and capacity to load weight on top. Use the stacking kit to secure them on top of each other.

- 2.** Ensure that all locks are secured when leaving the TrekDror unattended.

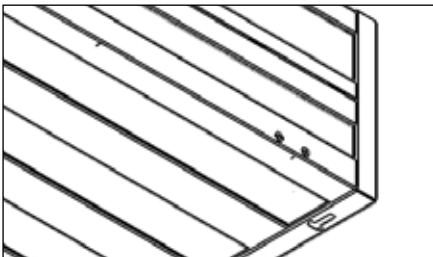

- 3.** We'd always recommend to mount the TrekDror on to the floor of a vehicle if used for transit.



---

# Transporting the unit

The design of the TrekDror makes transporting the product easy.

An empty TrekDror can be lifted by two people. Please always take care when moving the TrekDrors. It is always advised to lift the boxes when they are empty on contents.

Both locks on the TrekDror should always be locked when moving the unit.

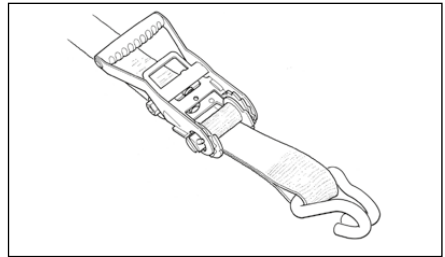
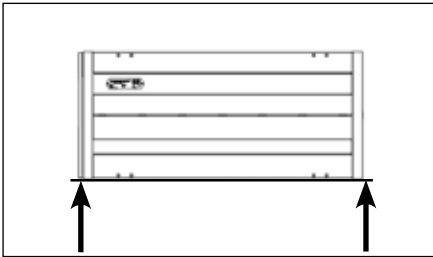

- 1.** When the TrekDror is in use, it is important to ensure that both front and back edges are supported on a surface. This will ensure that the loads are supported.

- 2.** During transportation, ensure the box is secured to the carrier using straps or other measures.



## Equipment care

The TrekDror is weather resistant and constructed with a durable powder coated finish, so it is suitable for outdoor use, however it does not mean it is waterproof. To prolong the life of the roller system, the TrekDror is recommended mainly for internal use.

Always ensure that the product data plate remains visible and in good condition, especially the unique serial number, as this is required should you need a replacement lock or key. If the serial plate will be hidden, always make a note of the serial number before fixing the unit in place.

## Ongoing maintenance

It is important to check that the TrekDror is not damaged before every use.

We recommend for you to check the roller system, hinges, locks, bolts and any optional extras every three months, to ensure that the TrekDror can operate fully. If the TrekDror will be under rigorous use, we recommend integrity checking regularly. The bolts must always be tight to ensure the drawer stays attached to the base.

Always carry out integrity checks before lifting the box.

---

# Warranty

Armorgard products are built to last, and all have a manufacturer's warranty of 12 months - please refer to the terms and conditions for what this covers.

We also keep replacement keys and offer replacement locks for all Armorgard products up to five years old. To get a replacement key, all you'll need is the distributor you purchased from, proof of purchase and your product's serial number, which can be found on the data plate of every product.

Do not force entry into the product, as this could affect the warranty. Always contact us if you require a replacement lock or key.

## Locks, keys and spare parts



Replacement keys



Outer casing



Roller bearings



Replacement deadlocks



Drawers



For additional support and easy access to spare or replacement parts, register your product following the QR code:





Find us on social media:



#### **UK Head Office**

Unit 14-16, Standard Way, Fareham Industrial Park, Fareham, Hampshire, PO16 8XB  
+44 (0) 23 9238 0280 | [sales@armorgard.co.uk](mailto:sales@armorgard.co.uk) | [www.armorgard.co.uk](http://www.armorgard.co.uk)

#### **France Office**

+ 33 (0) 4 81 16 06 69  
[commercial@armorgard.fr](mailto:commercial@armorgard.fr)  
[www.armorgard.fr](http://www.armorgard.fr)

#### **Australia Office**

+61 (0) 1300 131 751  
[sales@armorgard.com.au](mailto:sales@armorgard.com.au)  
[www.armorgard.com.au](http://www.armorgard.com.au)

#### **New Zealand Office**

0800 826 828  
[sales@armorgard.co.nz](mailto:sales@armorgard.co.nz)  
[www.armorgard.co.nz](http://www.armorgard.co.nz)

#### **North America Office**

1-877-794-2848  
[info@armorgardusa.com](mailto:info@armorgardusa.com)  
[www.armorgardusa.com](http://www.armorgardusa.com)