



Barcode: 5060452080758

transbank chem™

Product code: TRB1C

- » Fully welded unit, for storing and transporting hazardous liquids.
- » Suitable for vehicle mounting in line with regulations.
- » Designed for storing 2 x 5 litre cans.



Product features



Padlock secured



COSHH compliant



Sump capacity



Fire resistant



No detachable parts



Safety signage



Suitable for vehicles

Product specifications

Weight	13kg
Colour	Traffic yellow: RAL 1023
Suitable for	Transporting chemicals - 2 x 5L cans
Finished coating	Powder coated
Material & thickness	1.2mm steel
Quantity of keys	No
How are castors fitted?	Not applicable
Other sizes available	2 other sizes
Ventilation	Yes
Qty of shelves as standard	Not applicable

Dimensions

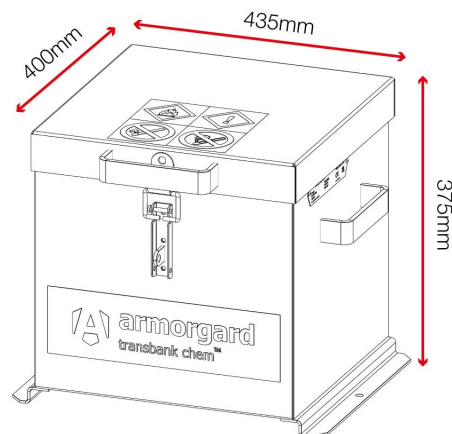

Optional extras - Contact Armorgard to find out more



Padlock LOCK-P50

